



ProFiller 3700 is the new standard in 300-hole bench-top capsule filling systems. Available with a European style Semi-automatic Orienter as ProFiller 3800. Experienced users like the higher output, fast size changes, easy to clean design & optional accessories. First time users love the ease-of-use & upgrade options.

### Easier To Use

- ❖ Easier to use than other 200 or 300 hole systems.
- ❖ Indicator gauges to assist in capsule orientation, separation and locking.
- ❖ Shipped fully assembled. Ready for use in less than 1 hour.
- ❖ Video tips at [www.profiller.com](http://www.profiller.com). Well-illustrated manual in multiple languages.

### Higher Output

- ❖ Unique features include lightweight, 2-piece Orienter (3700), Orienter locator and oversize Powder Tray & Push Plate.
- ❖ Tamper size range optimized for higher fill weights and faster filling.
- ❖ Adjustable capsule body height to make over-filling easier & faster.
- ❖ Fully locks capsules after filling.

### Pharmacopoeia Compliant

- ❖ Fill weights, USP/EP method within  $\pm 1-3\%$  of average. Typically all 300 capsules/batch are within  $\pm 4-7\%$  of target. More information at [www.profiller.com/3fw](http://www.profiller.com/3fw).
- ❖ Validation package available for cGMP compliance.
- ❖ Works with all capsules including gelatin, vegetarian/HPMC and starch capsules.

### Grows With You

- ❖ Add a Vibrator at any time.
- ❖ Change Parts for 3700 in Size 000-5, 00el-2el & AAA-D; for 3800 in Size 00-4.
- ❖ Order Filler without a Tamper for vibration only operation or in a lower height configuration for use under smaller powder hoods.

### GMP & Faster Clean-Out

- ❖ Dishwasher safe Inox (SS316) powder contact parts.
- ❖ Designed for fast disassembly & visual verification of cleaning.
- ❖ Filler base in lightweight, corrosion resistant anodized aluminum or upgrade to optional Inox (SS316).
- ❖ Filler's gear, cam and optional Vibrator are fully covered.

### Exclusive Accessories

- ❖ Partial Batch Kit for filling fewer than 300 capsules per batch.
- ❖ Capsule Counter.
- ❖ Over-Encapsulation attachments for tablets, capsules & caplets
- ❖ Caps Tray in Inox (SS316) or optional lightweight anodized aluminum.

**The easiest 300-hole filler to use!**  
**Up to 7200 to 9000\* capsules/hour.**

\*based on powder, operator speed & technique, excipients and weight variation limits. Output is similar for ProFiller 3700 and 3800.

Designed & Manufactured by:

**TORPAC<sup>®</sup>**

www.torpac.com info37@torpac.com  
T: 1-973-244-1125 F: 1-973-244-1365  
333 Route 46, Fairfield, NJ 07004, USA



### ProFiller 3700 & 3800 Filler

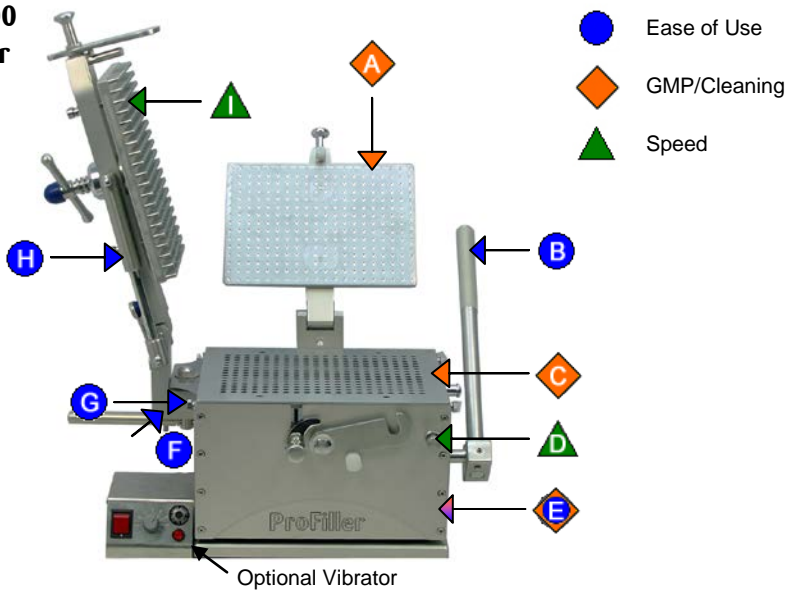

- Ease of Use
- ◆ GMP/Cleaning
- ▲ Speed

|   |  |
|---|--|
| <span style="color: orange;">◆</span> A | Inox (SS316) Locking Plate. No rubber pad to wear out or clean   |
| <span style="color: blue;">●</span> B   | Rear locking handle for fast, easy movement across front of machine. New internal gear design for easier locking           |
| <span style="color: orange;">◆</span> C | Dishwasher safe Inox (SS316) powder contact parts including Bottom Plate (not visible)                                     |
| <span style="color: green;">▲</span> D  | Adjustable capsule body height for easier & faster over-filling of capsules  |
| <span style="color: orange;">◆</span> E | Base Frame in light-weight anodized aluminum or upgrade to Inox (SS316)  |
| <span style="color: blue;">●</span> F   | Cam position indicator, great for training new operators   |
| <span style="color: blue;">●</span> G   | Over-size thumb screws for easy size change over   |
| <span style="color: blue;">●</span> H   | Dual springs make Tamper easier to lower & raise   |
| <span style="color: green;">▲</span> I  | Tamper pin size range optimized for faster filling & higher fill weights. Size ranges: 00 / 0-1 / 2-3 / 4 / 5 / 000 / 00el |



- ◆ J Body Sheets fully separate for easy cleaning & visual verification of cleaning

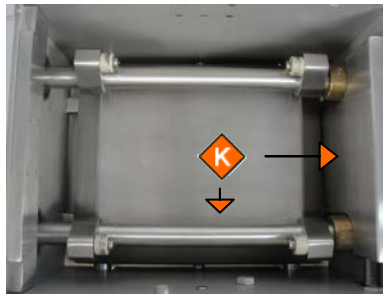

- ◆ K Cover for gear mechanism & Vibrator to minimize powder entry (inside view)

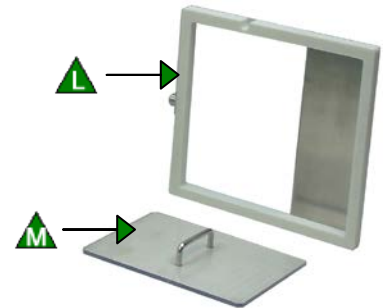

- ▲ L Powder Tray is double-depth for faster Spreading
- ▲ M Multi-use Push Plate speeds up operations

### 3700 Orienter

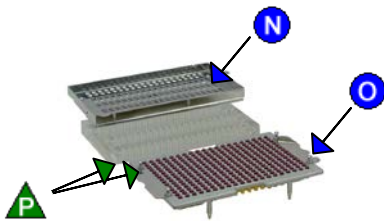

- N 2-piece Hand-Held Orienter. Shake only the lightweight Orienter Tray
- O Locking indicator confirms capsules are fully locked
- ▲ P Locating holes in Orienter and tapered locating pins for fast & accurate orientation of capsules into Caps Tray

### 3800 Orienter

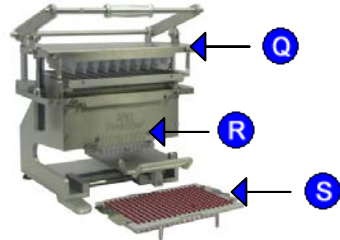

- Q Orienter Base common for Size 00-4. Traditional European style Orienter for operators who prefer it
- R Guide lines to locate Caps Tray for partial batches
- S Locking indicator confirms capsules are fully locked

**Adjustment-Free  
Size Changeovers**

**Shipped Fully Assembled**



| Item Description | Capsule Size | Item # | US\$ |
|------------------|--------------|--------|------|
|------------------|--------------|--------|------|

### 3700 Full System

Everything you need to fill one capsule size:

- Filler Base & Orienter Base
  - Change Parts for one capsule size
  - 300-pin Tamper
  - Powder Tray
  - Push Plate
  - Powder Spreaders
  - Storage Box for Loose Parts<sup>†</sup>
  - Measuring Bowls<sup>†</sup>
  - Capsule Bins<sup>†</sup>
- <sup>†</sup>not shown in photo



|                    |                 |         |
|--------------------|-----------------|---------|
| 00                 | P7T BHS 00      | \$5,900 |
| 0                  | P7T BHS 0       | \$5,900 |
| 1                  | P7T BHS 1       | \$5,900 |
| 2                  | P7T BHS 2       | \$5,900 |
| 3                  | P7T BHS 3       | \$5,900 |
| 4                  | P7T BHS 4       | \$5,900 |
| 000 (180-hole)     | P7T BHS 000     | \$6,450 |
| 00el-2el, 5, AAA-D | Email for Price |         |

Same Output as ProFiller 3800

### Change Parts for Additional Sizes

Use table below only if you already fill any of sizes 00-4 or 00el-2el. Otherwise, contact us.

Change parts for one capsule size include:

- Body Sheet Set
- Caps Tray
- Locking Plate Spacer
- Orienter Tray

All Change Parts are Inox (Stainless Steel 316) and include a plastic storage box.

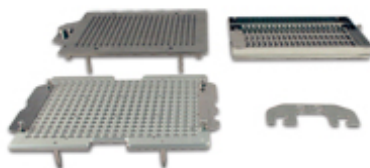

|                             |                 |         |
|-----------------------------|-----------------|---------|
| 00*                         | P7T CPS 00      | \$1,525 |
| 0*                          | P7T CPS 0       | \$1,525 |
| 1*                          | P7T CPS 1       | \$1,525 |
| 2*                          | P7T CPS 2       | \$1,525 |
| 3*                          | P7T CPS 3       | \$1,525 |
| 4**                         | P7T CPS 4       | \$1,525 |
| 000 (180-hole) <sup>†</sup> | P7T CPCK 000    | \$3,170 |
| 00el-2el, 5, AAA-D          | Email for Price |         |

\* If you can fill Size 4 only also order Bottom Plate P78 BBP 00-3 for \$690.

\*\* If you do not have Size 5 change parts also order Bottom Plate P78 BBP 4-5 for \$690.

<sup>†</sup> Includes Orienter Base, Capsule Locking Plate and Bottom Plate

### Tamper for Additional Size (optional)

300-Pin Tamper is Inox (Stainless Steel 316)



|               |               |       |
|---------------|---------------|-------|
| 00            | P78 T300P 00  | \$370 |
| 0-1           | P78 T300P 0-1 | \$370 |
| 2-3           | P78 T300P 2-3 | \$370 |
| 4             | P78 T300P 4   | \$370 |
| 000 (180-pin) | P78 T300P 000 | \$460 |

### Powder Vibrator

Optional Vibrator recommended for faster filling of powders that bridge or are granular, fluid or flour-like. It also reduces weight variation of fine powders. Fully enclosed in Inox (SS316). Filler sits over Vibrator. Also available with Inox (SS316) Base Plate.



| Voltage/Frequency    | Item #                    | US\$    |
|----------------------|---------------------------|---------|
| 110-120 Volts/60Hz   | P78 VIB 110V              | \$1,980 |
| 220-240 Volts/50Hz   | P78 VIB 230V              | \$1,980 |
| 100 Volts/50 or 60Hz | P78 VIB 100V <sup>†</sup> | \$1,980 |

<sup>†</sup> PM VIB 100V is for Japan. It is supplied in 50Hz for East Japan and 60Hz for West Japan. Please specify your requirement.

### 3700 Inox (Stainless Steel 316) Filler Base Upgrade

Upgrade your Filler Base from Anodized Aluminum to Inox (Stainless Steel 316). Add \$1000 to the price of a standard system of the same size.

Change Parts and Tampers for "3700 Standard" and "3700 Inox (SS316)" are common, as they are made from Inox (SS 316).

3700 Inox (SS316) cannot be used with a standard Powder Vibrator. A special Powder Vibrator is required for \$2100.

See [www.profiller.com/3700ss](http://www.profiller.com/3700ss) for item codes and net weight.

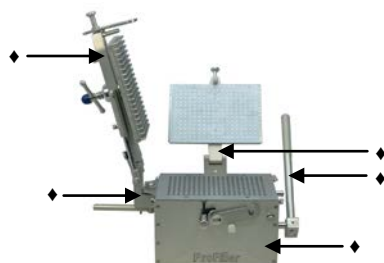

Filler Inox (Stainless Steel 316)

◆ Additional Parts in Inox (SS316)



Vibrator Inox (Stainless Steel 316)

### Alternate Configurations

ProFiller 3700 is also available with no tamper for those using vibration only, and reduced height configurations for use under a powder hood. See page 8 for additional configurations.

**⚠ For Customers who Prefer a European Style Orienter ⚠**

| Item Description  | Capsule Size            | Item #                     | US\$     |
|---|-------------------------|----------------------------|----------|
| <b>3800 Full System</b>   |                         |                            |          |
| <b>Everything you need to fill one capsule size:</b>  |                         |                            |          |
| <ul style="list-style-type: none"> <li>• Filler Base &amp; Orienter Base</li> <li>• Change Parts for one capsule size</li> <li>• 300-pin Tamper</li> <li>• Powder Tray</li> <li>• Push Plate</li> <li>• Powder Spreaders</li> <li>• Measuring Bowls<sup>†</sup></li> <li>• Storage Boxes<sup>†</sup></li> <li>• Capsule Bins<sup>†</sup></li> </ul> <p><sup>†</sup>not shown in photo</p> |                         |                            |          |
|  <p>European Style Orienter</p> <p>Optional Vibrator</p>   | 00                      | P8T BSA 00                 | \$10,900 |
|   | 0                       | P8T BSA 0                  | \$10,900 |
|   | 1                       | P8T BSA 1                  | \$10,900 |
|   | 2                       | P8T BSA 2                  | \$10,900 |
|   | 3                       | P8T BSA 3                  | \$10,900 |
|   | 4                       | P8T BSA 4                  | \$10,900 |
|   | 000, 00el-2el, 5, AAA-D | Available in 3700 / 3700OE |          |

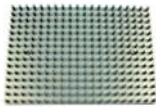

| <b>Change Parts for Additional Sizes</b>   |                           |                            |         |
|--|---------------------------|----------------------------|---------|
| Use table below only if you already fill any of sizes 00-4. Otherwise, contact us  |                           |                            |         |
| <b>Change parts for one capsule size include:</b>  |                           |                            |         |
| <ul style="list-style-type: none"> <li>• Body Sheet Set</li> <li>• Caps Tray</li> <li>• Locking Plate Spacer</li> <li>• Orienter Tray</li> </ul> <p>All Change Parts are Inox (Stainless Steel 316) and include a plastic storage box.</p> |                           |                            |         |
|   | 00*                       | P8S CPS 00                 | \$1,690 |
|  | 0*                        | P8S CPS 0                  | \$1,690 |
|  | 1*                        | P8S CPS 1                  | \$1,690 |
|  | 2*                        | P8S CPS 2                  | \$1,690 |
|  | 3*                        | P8S CPS 3                  | \$1,690 |
|  | 4**                       | P8S CPS 4                  | \$1,690 |
|  | 000, 00el - 2el, 5, AAA-D | Available in 3700 / 3700OE |         |

\* If you can fill Size 4 only also order Bottom Plate P78 BBP 00-3 for \$690.  
 \*\* If you do not have Size 5 change parts also order Bottom Plate P78 BBP 4-5 for \$690.

| <b>Tamper for Additional Size (optional)</b>  |     |               |       |
|---|-----|---------------|-------|
| <p>300-Pin Tamper is Inox (Stainless Steel 316)</p>  |     |               |       |
|   | 00  | P78 T300P 00  | \$370 |
|   | 0-1 | P78 T300P 0-1 | \$370 |
|   | 2-3 | P78 T300P 2-3 | \$370 |
|   | 4   | P78 T300P 4   | \$370 |
|   | 5   | P78 T300P 5   | \$370 |

| <b>Powder Vibrator</b>   |                          |               |             |
|--|--------------------------|---------------|-------------|
| <p>Optional Vibrator recommended for faster filling of powders that bridge or are granular, fluid or flour-like. It also reduces weight variation of fine powders. Fully enclosed in Inox (SS316). Filler sits over Vibrator. Also available with Inox (SS316) Base Plate.</p>  | <b>Voltage/Frequency</b> | <b>Item #</b> | <b>US\$</b> |
|  | 110-120 Volts/60Hz       | P78 VIB 110V  | \$1980      |
|  | 220-240 Volts/50Hz       | P78 VIB 230V  | \$1980      |
|  | 100 Volts/50 or 60Hz     | P78 VIB 100V* | \$1980      |

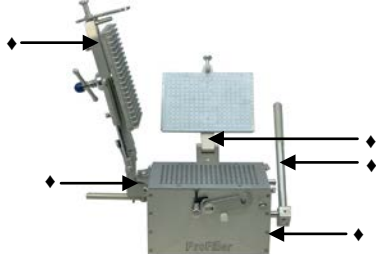
\* PM VIB 100V is for Japan and comes in 50Hz for East Japan and 60Hz for West Japan. Please specify your requirements.

| <b>3800 Inox (Stainless Steel 316) Filler Base Upgrade</b>   |  |  |  |
|--|--|--|--|
| <p>Upgrade your Filler Base from Anodized Aluminum to Inox (Stainless Steel 316). Add \$1000 to the price of a standard system of the same size.</p> <p>Change Parts and Tampers for "3800 Standard" and "3800 Inox (SS316)" are common, as they are made from Inox (SS316).</p> <p>3800 Inox (SS316) cannot be used with a standard Powder Vibrator. A special Powder Vibrator is required for \$2100.</p> <p>See <a href="http://www.profiller.com/3800ss">www.profiller.com/3800ss</a> for item codes and net weight.</p> |  <p>Filler Inox (Stainless Steel 316)</p> |  <p>Vibrator Inox (Stainless Steel 316)</p> | <p>◆ <b>Additional Parts in Inox (SS316)</b></p> |

**Alternate Configurations**

ProFiller 3800 Standard model is sold with an Anodized Aluminum Base frame, attached Tamper, and a fixed locking plate. ProFiller 3800 is also available with no tamper for those using vibration only, and reduced height configurations for use under a powder hood. See page 8 for additional configurations.



### Installation Requirements



- Width:** 48 inches (120cm) is recommended width if Filler and Orienter are operated on same table.  
34 inches (90 cm) is minimum width to operate Filler if Orienter is kept on another table.
- Depth:** 30 inches (75cm) depth is recommended.  
24 inches (65cm) is the minimum depth.
- Height:** 29 inches (73cm) or office desk height is recommended.

Electricity is required for optional Vibrator. No compressed air or water is required for operation.

| Filler | Hand Held Orienter | European Style Orienter |
|--------|--------------------|-------------------------|
|        |                    |                         |

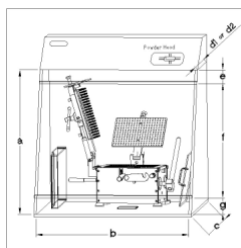

For detailed measurements and information on selecting a powder hood, visit <http://www.profiller.com/powder-hood>.

### Shipping Information







| Item   | Boxes | Shipping Wt |       | Net Wt |      |
|--|-------|-------------|-------|--------|------|
|  |       | Kg          | Lbs   | Kg     | Lbs  |
| <br><b>ProFiller 3700</b><br>Bench Top Filler & Hand Held Orienter<br>for one capsule size | Box 1 | 12.5        | 28.0  | 6.0    | 13.0 |
|  | Box 2 | 47.0        | 103.0 | 26.0   | 57.0 |
| Extra Change Parts   |       | 25.0        | 5.7   | 6.5    | 14   |
| Optional Vibrator  |       | 14.5        | 32.0  | 10.5   | 23.0 |

| Item  | Boxes | Shipping Wt |       | Net Wt |      |
|---|-------|-------------|-------|--------|------|
|   |       | Kg          | Lbs   | Kg     | Lbs  |
| <br><b>ProFiller 3800</b><br>Bench Top Filler & European Style<br>Orienter for one capsule size | Box 1 | 13.0        | 29.0  | 6.5    | 14.0 |
|   | Box 2 | 47.0        | 103.0 | 26.0   | 57.0 |
|   | Box 3 | 52.5        | 116.0 | 25.2   | 55.0 |
| Extra Change Parts  |       | 11.5        | 25.0  | 5.5    | 12.0 |
| Optional Vibrator   |       | 14.5        | 32.0  | 10.5   | 23.0 |





|                                |   |
|--------------------------------|---|
| <br><b>Inox (SS316) Filler</b> | For Inox (SS316) Filler add 12 kg (27 lbs) to shipping and 11kg (24lbs) to the net weight of Box 2.<br>For Inox (SS316) Vibrator add 2.5 kg (6 lbs) to shipping and net weight of box for vibrator. |
|--------------------------------|---|



### Optional Accessories (ProFiller 3700 / 3800)

| Item Description   |  | Capsule Size | Item #               | US\$   |
|--|--|--------------|----------------------|--------|
| <b>Powder Tray with Clamps</b><br>For pharmacy compounding and very fine powders. Four built-in clamps secure Powder Tray to Filler, reducing powder loss under Powder Tray. Useful when working with controlled substances (narcotics).                   |   | All Sizes    | P3X PTC              | \$320  |
| <b>Lifting Handle Extension</b><br>Attaches to Lifting Handle to make capsule separation and locking under a powder hood easier.   |   | All Sizes    | P78 LHE              | \$160  |
| <b>Over Fill (OF) Parts</b><br>Standard change parts allow capsules bodies to be lowered by 2mm (Size 00 by 1.2mm) below the surface of the filler. OF Change Parts allow lowering by an additional 2 mm for twice the overfill capacity (3X for Size 00). |   | 000-1        | P3X OFF <sup>†</sup> | \$1050 |
| <b>Capsule Counters</b><br>Divide your batch of capsules into 3 groups of 100 capsules, 5 groups of 60 or 10 groups of 30. Anodized aluminum   |   |              | P3X CTR 3X100        | \$230  |
|  |   |              | P3X CTR 5X60         | \$250  |
|  |  |              | P3X CTR 10X30        | \$290  |
|  | 3x100  | 5x60         | 10x30                |        |

### Optional Accessories (ProFiller 3700 ONLY)

|   |   |                    |                       |                        |       |
|---|---|--------------------|-----------------------|------------------------|-------|
| <b>Capsule Locking Plate &amp; Capsule Locker</b><br>For fully locking capsules with coarse or sticky powders e.g. salt, dolomite, frankincense, charcoal. Capsule Locking Plate is common for sizes 00-4. Both Locker & Locking Plate are required. Capsule Locker is size specific and locks 50 capsules at a time. |   | 00-4               | P67 CLP 00-4          | \$200                  |       |
|   |  | 00-4               | P67 CL <sup>†</sup>   | \$30                   |       |
| <b>Partial Batch Kit</b><br>Fill fewer than 300 capsules per batch. Includes 1 each of Orienter Divider, Powder Tray Divider & Mini Powder Spreader. Order 30-pin Tamper separately.  |  | All Sizes          | P67 PBK               | \$85                   |       |
| <b>30-pin Tamper</b><br>For use with ProFiller 3700 Partial Batch Kit. Tamper in Sizes 00, 0-1, 2-3, 4.   |  | 00-4               | P67 T30P <sup>†</sup> | \$85                   |       |
| <b>Caps Tray For 3700</b><br>Purchase an additional Caps Tray<br>*Light-weight anodized aluminum Caps Tray is not Dishwasher Safe.  |  | Anodized Aluminum* | All Sizes             | P67 CT AL <sup>†</sup> | \$380 |
|   |   | Inox (316 SS)      | All Sizes             | P67 CT SS <sup>†</sup> | \$450 |



### Optional Accessories (ProFiller 3800 ONLY)

| Item Description   |   | Capsule Sizes      | Item # | US\$                   |       |
|--|---|--------------------|--------|------------------------|-------|
| <b>Caps Tray For 3800</b><br>Purchase an additional Caps Tray<br>*Light-weight anodized aluminum Caps Tray is not Dishwasher Safe. |  | Anodized Aluminum* | 00-4   | P8S CT AL <sup>†</sup> | \$380 |
|  |   | Inox (316 SS)      | 00-4   | P8S CT SS <sup>†</sup> | \$450 |

<sup>†</sup> Specify Capsule Size when ordering, some accessories are not available for special sizes (000, 5, 00el-2el & AAA-E).



### Over-Encapsulation Accessories (ProFiller 3700 / 3800)

| Item Description  |   | Specification Requirements             | Item #                  | \$US                             |
|---|---|--|-------------------------|----------------------------------|
| <b>Tablet Fill Attachment</b><br>Over-encapsulate round tablets 6.0-7.3 mm diameter and 2.0-3.5 mm height.<br>For round tablets outside the size range listed above, order a custom TFA (delivery 4-6 weeks).   |  | None                                   | P3X ATF STD             | \$600                            |
|   |   | Tablet Dimensions & Outer Capsule Size | P3X ATF Custom          | \$1300                           |
| <b>Caplet Fill Attachment</b><br>For caplets or non-round tablets. Engineering drawing of tablet required. Delivery 4-8 weeks.  |  | Caplet Dimensions & Outer Capsule Size | P3X ACF Custom          | \$1300                           |
| <b>Orienter for Capsule-in-Capsule</b><br>Fill capsules inside capsules. Order Orienter for inner capsule size.<br>To determine what size capsule size you require see our Capsule-In-Capsule size chart <a href="http://www.profiller.com/cicsc">www.profiller.com/cicsc</a> |  | Specify Inner Capsule 00-4             | P3X ACI <sup>†</sup>    | \$720                            |
|   |   | Specify Inner Capsule 1el or 2el       | P3X ACI EL <sup>†</sup> | \$900                            |
| <b>OE Guide Tray</b><br>All Over Encapsulation Attachments include a guide tray to correctly locate the attachment and guide the test products into the capsule.  |  | n/a                                    | P3X AGT                 | Included with all OE Attachments |

<sup>†</sup> Specify capsule size.

### 3700/3800 Filler Base Options



High GMP Model<sup>a</sup>

Base Frame in Inox (SS316)  
See page 3 for 3700  
See page 4 for 3800

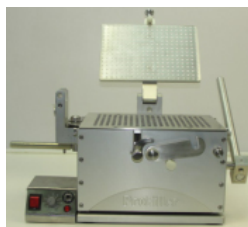

No Tamper<sup>a b c d</sup>

Filler without Tamper.  
Requires Hand-Held 300-pin  
Tamper or Vibrator.



Low Height with Tamper  
for use with Powder Hoods<sup>a b</sup>

Filler with loose Locking Plate &  
special Handle. Tamper is on  
rear of Filler.



Low Height No Tamper  
for use with Powder Hoods<sup>a b c d</sup>

Filler with loose Locking Plate,  
special Handle & no Tamper.  
Requires Hand-Held 300-pin  
Tamper or Vibrator.

Video: [www.profiller.com/lpvideo](http://www.profiller.com/lpvideo)

|        |        |        |          |          |
|--------|--------|--------|----------|----------|
| Item # | add SS | add NT | add LHWT | add LHNT |
| Suffix |        |        |          |          |

### Hand-held 300-pin\* Tamper

For use with ProFiller 3700 Lower Height Configuration without a tamper (NT and LHNT). Includes self-standing handle.



#### Capsule Size

00-4

#### Item #

P3X T300P<sup>e</sup>

#### \$US

\$410.00

000-00el

P3X T180P<sup>e</sup>

\$500.00

<sup>a</sup> Order Vibrator separately.

<sup>b</sup> Available in High GMP model.

<sup>c</sup> Deduct \$725 for No Tamper Arm + No Tamper. Tamper arm + Tamper, in one capsule size, can be ordered later for \$825.

<sup>d</sup> Optional Hand-held 300 pin tamper is available.

<sup>e</sup> Specify capsule size range: 00, 0-1, 2-3 or 4. \*180-pin for Sizes 000-00el

### Capsule Size Chart

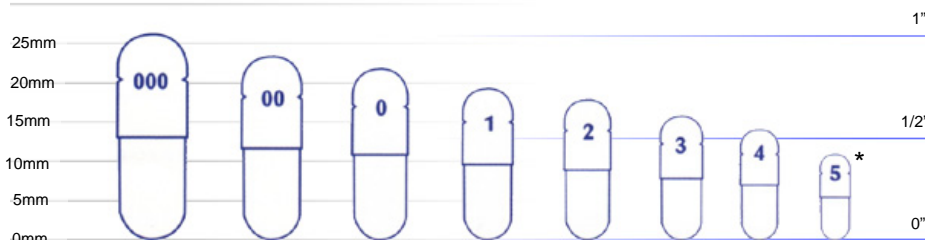

Approximate Locked Capsule Sizes

## Frequently Asked Questions

### 1. What is the output?

ProFiller 3700 and 3800 fill up to 7200 – 9000 capsules per hour for most powders. Our engineers have included features, some patented, that make the ProFillers faster and easier to use. The lower output is for fine powders. The higher output is for coarse free flowing powders. Your results will vary based on powder flow properties, operator speed & technique and use of excipients.

### 2. What types of capsules can I fill?

ProFillers have been tested with different brands and types of capsules including gelatin, vegetarian/HPMC and starch capsules.

### 3. What size capsules can I fill?

The 3700 fills sizes 000-5, 00el-2el, and AAA-D. The 3800 fills sizes 00-4. To order Change Parts for the 3700 see page 3 and for 3800 see page 4.

### 4. Do you have more information on Fill Weight Variation & Achieving Higher Fill Weights?

Fill weights, USP/EP method, within  $\pm 1-3\%$  of average. When weighed individually (a stricter standard than USP/EP) typically all 300 capsules/batch are within  $\pm 4-7\%$  of target. For more information visit [www.profiller.com/3fw](http://www.profiller.com/3fw).

### 5. Can I see the system before I buy?

You can view our online videos at [www.profiller.com](http://www.profiller.com)

### 6. Can I over-encapsulate or double-blind tablets, capsules and caplets?

Yes, you can. See page 8 and then contact us for more information.

### 7. Can I fill liquids or sticky powders?

Yes, you can fill capsules with sticky powders or non-aqueous liquids. Capsules filled with liquids for stability or clinical trials, if not sealed, will need to be kept vertical to minimize leakage between the cap and body. Capsules filled with non-aqueous liquids for commercial sale require sealing using equipment purchased separately. When filling sticky powders, use of a Vibrator can improve performance by eliminating Tamper pin contact with powder. For more information visit [www.profiller.com/vibrators/use](http://www.profiller.com/vibrators/use).

### 8. Can the ProFiller be cleaned in an automatic dishwasher or autoclaved?

All powder contact parts are dishwasher safe to 70 °C (160 °F). For more information visit [www.profiller.com](http://www.profiller.com) and download the manual.

### 9. What are the Materials of Construction?

For more information visit [www.profiller.com](http://www.profiller.com) and download the manual.

### 10. What are the installation and utility requirements?

See page 6 for the recommended table size and height and information on operating under a powder hood. No utilities (electricity, compressed air or water) are required unless you order the optional Vibrator. The vibrator's electrical specifications are on page 3. If you have different electrical requirements specify them in your order.

### 11. Is a CE certificate Available?

A "Declaration of Conformity" is included with each system. A CE certificate is included with the optional Vibrator.

## Other ProFiller Products



### ProFiller® 1100

Hand-held fillers in 100 holes.  
Up to 3200 capsules/hour.  
Sizes 000-5 including el size and AAA-D.



### ProFiller® 3600

Hand-held filler up to 3600 capsules/hour.  
Sizes 000-4. Optional vibrator.

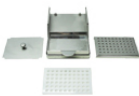

### ProCoater

Capsule and Caplet Coater.  
Ideal for Enteric Coating.



### ProFunnel

Inox (SS 316) Funnel for precision capsule filling on a balance. All sizes including veterinary sizes.



### ProMixer™ 750

Powder Mixer/Blender for uniform powder mixtures. choose from 6 different Inox (SS 316) shells for maximum flexibility.



### Veterinary Fillers

Fill veterinary capsule sizes 13-Su07.  
Hand-held and Bench-top fillers.

